

Architectural openings and  
Codes & Standards - **the missing link.**

---



**Altaf A. Afridi, PMP, LEED AP, FDAI**

Riyadh 30 Sep 2013, Jeddah 1 Oct 2013

**Welcome**



Safety Design in Buildings



# AIA Middle East

Fire Safety Engineering, Smoke  
Management, Architectural Openings  
Standards & Specifications

Riyadh (Sep 30, 2013)

Jeddah (Oct 1st, 2013)

Altaf Ahmed Afridi



Credit(s) earned on completion of this course will be reported to **AIA CES** for AIA members. Certificates of Completion for both AIA members and non-AIA members are available upon request.

**CES** for continuing professional education. As such, it does not include content that may be deemed or construed to be an approval or endorsement by the AIA of any material of construction or any method or manner of handling, using, distributing, or dealing in any material or product.

---

—  
Questions related to specific materials, methods, and services will be addressed at the conclusion of this presentation.

This course is registered with **AIA**



# Copyright Materials

This presentation is protected by US and International Copyright laws. Reproduction, distribution, display and use of the presentation without written permission of the speaker is prohibited.

© DORMA Gulf 2012





---

# Course Description

---

Performance based fire safety engineering design relies on the use of fire engineering principles, calculations and/or appropriate software modelling tools to satisfy the intentions of the Fire Code. The performance-based approach is unique in that its provisions spell out the intent of the code qualitatively but the means of achieving the desired intent of the code is open to the building practitioner.

The course will also review smoke management system basics as required by the local Standards and the NFPA Codes. It will illustrate with case studies how these requirements are typically not being achieved in the GCC, and will provide information on how to verify existing building system performance and how to design functional tower smoke management systems for future projects.

The course will also discuss how design specifications must relate to the fire strategy, applied codes such as British or American as well as standards and fire tests. It will point out examples of getting it right and what happens when it goes wrong.



# Learning Objective

---

At the end of the this session, participants will be able to:

Understand basics of Architectural openings specifications as per relative codes and standards.



# Safety Design in Buildings

# Building Fire

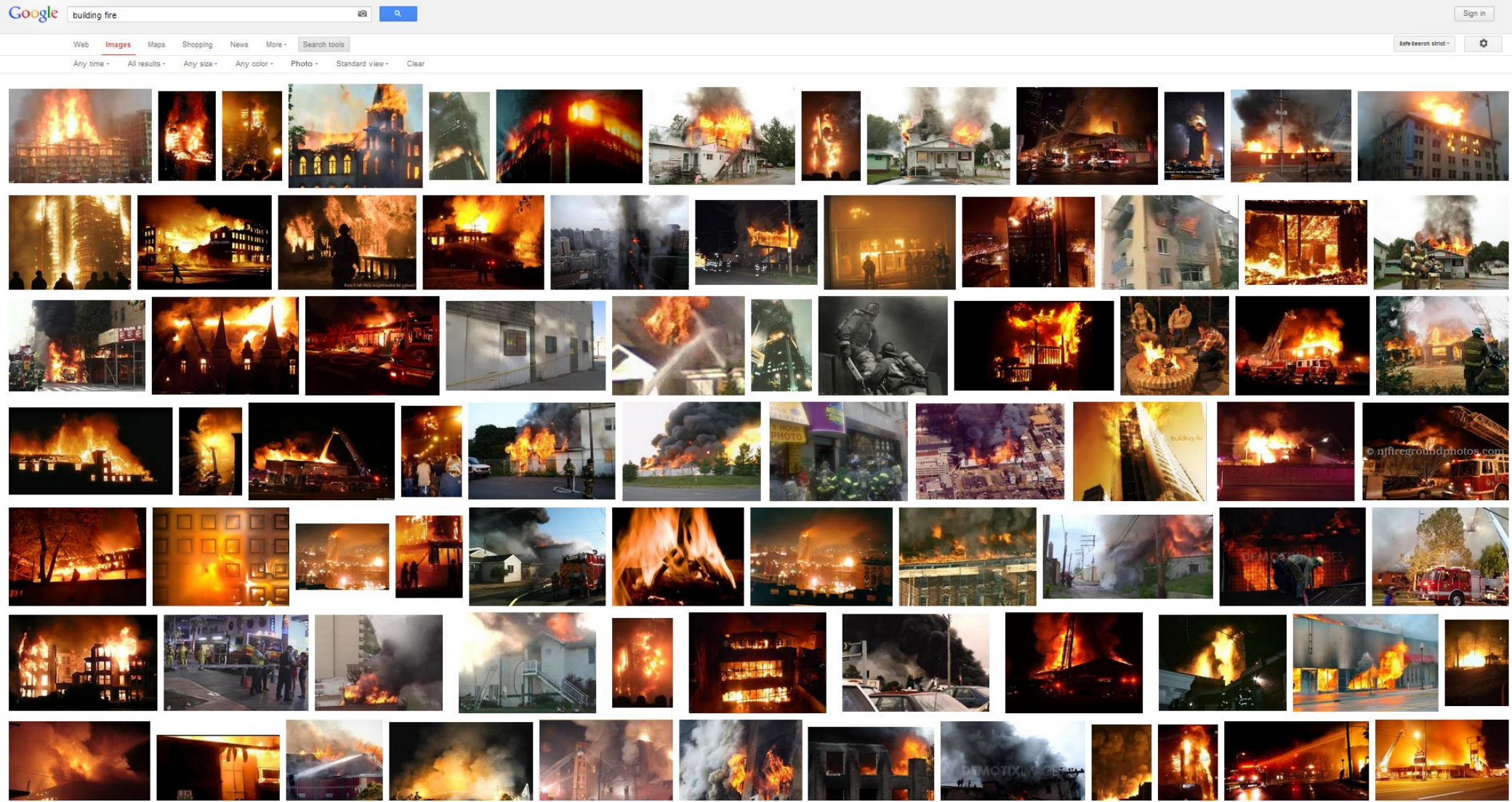



# Safety Design in Buildings

# Office Building fire

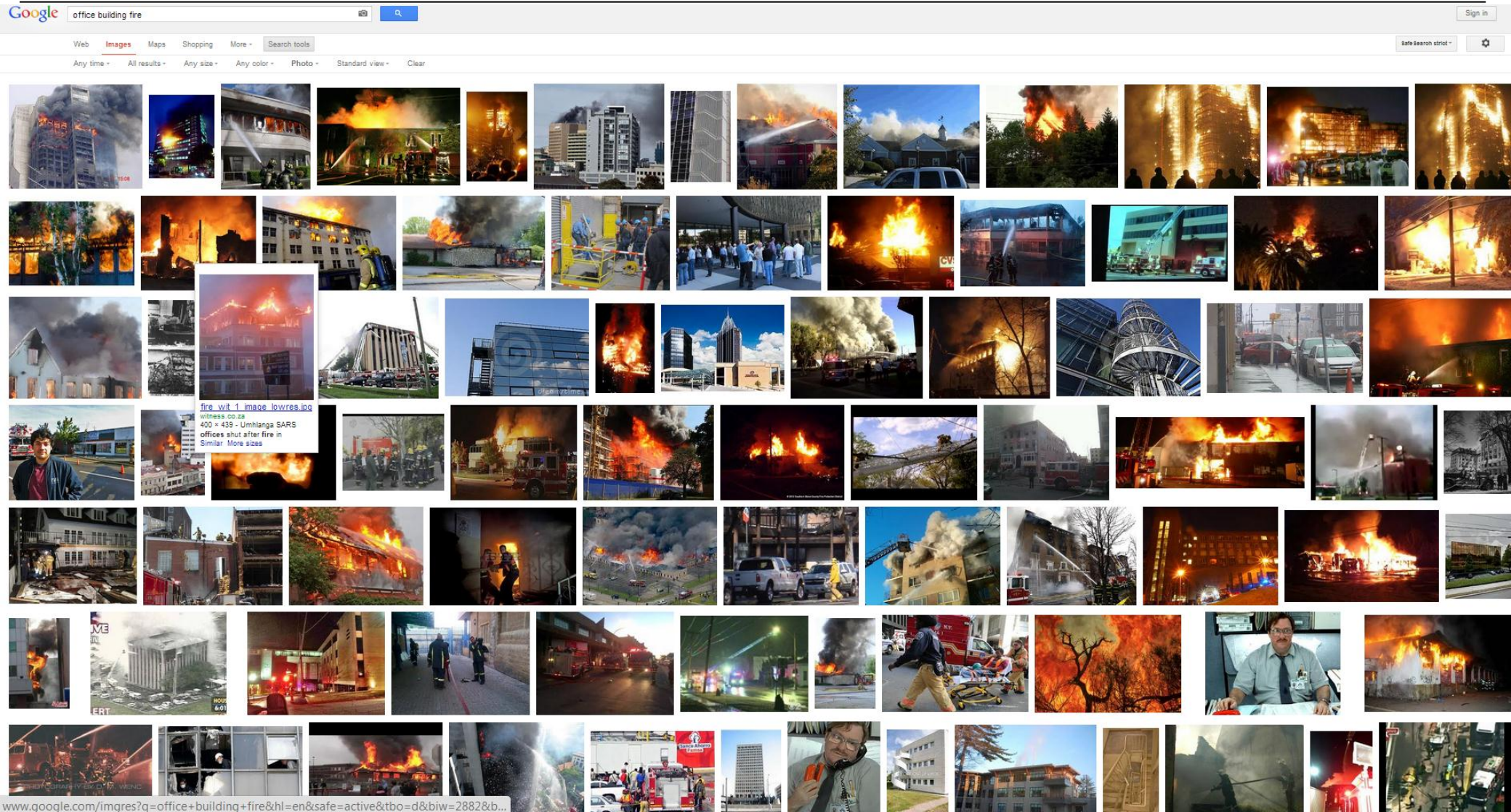







# Safety Design in Buildings

# High rise building fire

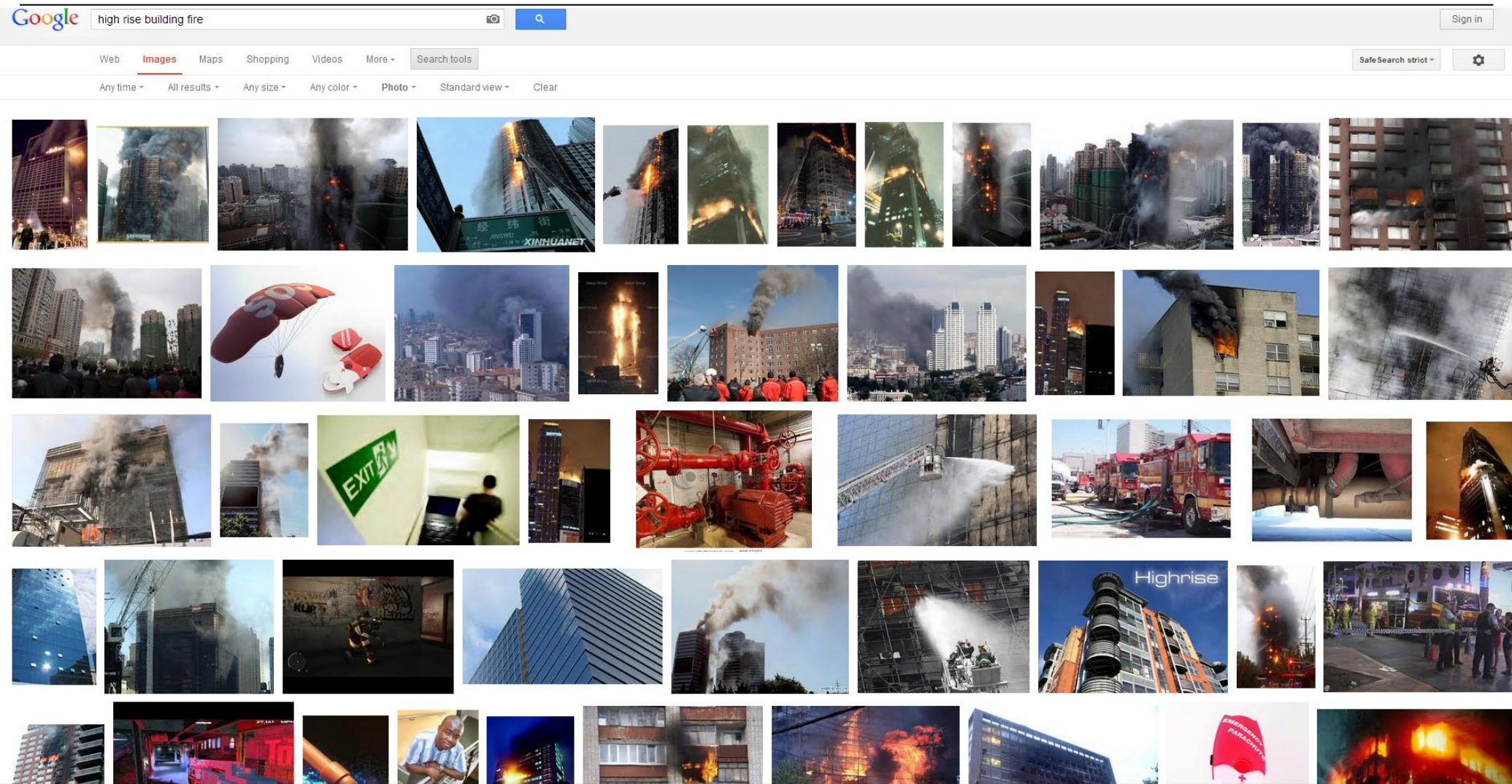



# Safety Design in Buildings

# Dubai Building fire



... area in Dubai on Wednesday.  
423 x 270 - 17k - jpg  
[www.msnbc.msn.com](http://www.msnbc.msn.com)



... of the Dubai Multi-Commodities ...  
510 x 390 - 33k - jpg  
[www.uaepropertytrends.com](http://www.uaepropertytrends.com)

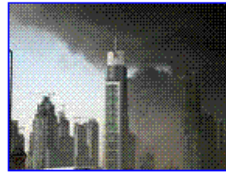

Another fire in Dubai has killed at ...  
800 x 600 - 41k - jpg  
[internationalpropertyinvestment.com](http://internationalpropertyinvestment.com)



Two new vessels for the Dubai Fire ...  
500 x 375 - 126k - jpg  
[www.flickr.com](http://www.flickr.com)  
[ [More from flickr.com](#) ]



... in Dubai, 27 August 2007. A fire ...  
610 x 404 - 65k - jpg  
[www.daylife.com](http://www.daylife.com)  
[ [More from cache.daylife.com](#) ]



Dubai fire update: 4 dead, ...  
510 x 390 - 38k - jpg  
[renthusiast.wordpress.com](http://renthusiast.wordpress.com)  
[ [More from gulfnews.com](#) ]



... after it caught fire in Dubai, ...  
220 x 233 - 21k - jpg  
[www.cbc.ca](http://www.cbc.ca)



Fire at the Jumeirah Lakes Towers ...  
1229 x 922 - 107k  
[flickr.com](http://flickr.com)



Dubai Media City Fire  
400 x 300 - 46k - jpg  
[newlywedindubai2.blogspot.com](http://newlywedindubai2.blogspot.com)



... the Abu Dhabi to Dubai highway.  
470 x 255 - 29k - jpg  
[www.smh.com.au](http://www.smh.com.au)  
[ [More from www.smh.com.au](#) ]



... the firefighting force of Dubai.  
450 x 299 - 65k - jpg  
[www.corvetteblog.com](http://www.corvetteblog.com)

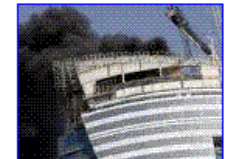

Fire Accident in Dubai!  
510 x 390 - 37k - jpg  
[our-current-events.blogspot.com](http://our-current-events.blogspot.com)



HUMMER H2, Middle-East Fire-Fighting ...  
400 x 267 - 22k - jpg  
[image.automotive.com](http://image.automotive.com)



... in Dubai, 27 August 2007. A fire ...  
610 x 404 - 52k - jpg  
[www.daylife.com](http://www.daylife.com)

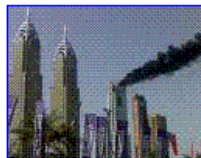

Dubai building on fire 01  
500 x 375 - 57k - jpg  
[www.zoomr.com](http://www.zoomr.com)



Major car crash in UAE Show details  
600 x 397 - 39k - jpg  
[www.smh.com.au](http://www.smh.com.au)



... Abu Dhabi to Dubai this morning ...  
500 x 375 - 71k - jpg  
[stephenlloyd.blogspot.com](http://stephenlloyd.blogspot.com)



Oasis Center On FIRE!  
500 x 375 - 65k  
[flickr.com](http://flickr.com)

# Safety Design in Buildings

# Sharjah and Abu Dhabi



A fire gutted 17 floors of a 33-storey residential building in the Al Nahda area of Sharjah



FRIDAY, JULY 16, 2010

Massive fire guts Sharjah residential building



Al Tayer Tower in flames (left) and after firemen have controlled the blaze on Saturday morning (right)

ABU DHABI  
Two people have died and 32 more were injured after an early morning fire in the Tourist Club area of the capital.





## 13 workers killed in Bahrain blaze horror

Manama, January 12, 2013

Thirteen workers were yesterday burnt to death in a fire that raged through a three-storey building used as a bachelor's camp in Manama, Bahrain's capital.

The victims of the blaze, in the Mukharqa neighbourhood, are yet to be identified, an Interior Ministry official was quoted as saying by a report in the Gulf Daily News (GDN), our sister newspaper.

The bodies have been transferred to the Salmaniya Medical Complex mortuary while the injured are undergoing treatment at the hospital.



## Bahrain's traditional market in Isa Town gutted by massive fire

Updated: 2012-07-16 02:16:00

(Xinhua)

Print Mail Large Medium Small

Share 9

MANAMA, July 15 (Xinhua) -- Firefighters are trying to control a fire that spread Sunday across a traditional market in Bahrain's Isa Town and destroyed several shops.

The fire has been continuing for over six hours and roads leading to the area were blocked by the police as a precautionary measure.

It resulted in major losses, but no casualties were reported.

The Interior Ministry said civil defense team were present at the site to extinguish the fire.

This is the second fire in almost five years that has destroyed the row of shops in the area, which is popular for its flea market and shops selling furniture and rugs.



# Safety Design in Buildings

# Saudi Arabia

**the saudi** University of Al-Qadisiyah  
Nationally Accredited Degree Online Degree  
Flexible schedule

Search:  Today All Issues Go Advanced Search Wednesday, 22 December

**MAIN NEWS**

- HOME
- NATION
- OPINION
- WORLD
- BUSINESS
- SPORTS

**SAUDIGAZETTE DIGITAL**

**WAREHOUSES GUTTED IN HUGE RIYADH FIRE**  
By Mansour Al-Shehri

RIYADH - The Civil Defense in Riyadh on Tuesday used 70 firefighters and a helicopter to douse a huge fire which gutted 49 timber and charcoal warehouses near Al-Mansouriyah District.

No loss of lives was reported. First Lieutenant Muhammad Mafii Al-Hamadi, a spokesman of the Civil Defense in Riyadh, said strong winds spread the fire. He said the operation room had received a distress call about a huge fire at a warehouse near Al-Mansouriyah District. The strong wind spread the fire to 48 other warehouses. There are 200 warehouses in the area. He said that due to the intensity of the fire, the Civil Defense Administration had sent a further 11 firefighters teams, three rescue teams, a number of foam vehicles and a helicopter. He said the teams managed to contain the fire and prevent it spreading further. He said the cause of the fire has not yet been determined. — OkazSO

[Fire Resistant Shutters](#) www.bust-qawder.co.uk

Fire in a chemical warehouse in the south part of Riyadh city

Followed-up by His Royal Highness Prince Salman Bin Abdulaziz, Governor of Riyadh, and His Royal Highness Prince Sattam Bin Abdulaziz Deputy of the Governor of Riyadh.



The Civil Defense Corps of Riyadh took control over a fire in a warehouse south of the city of Riyadh. This storage was specialized for chemical substances. The civil defense operation room received the report at 21:15, and instantly 10 firefighting teams, 4 rescue groups, 2 evacuating corps, 2 intervention teams in industrial accidents, an intervention group in dangerous chemical accidents, in addition to 35 units of transferring water.

**KINGDOM**  
arab news

Tuesday, December 21, 2010



Civil Defense personnel are busy putting out a fire that hit a residential compound in Riyadh on Monday. (AN photo, courtesy Civil Defense Directorate, Riyadh)

## Fire hits Riyadh compound

## Gulf | Saudi Arabia

### Makkah hotel fire under investigation

Investigations have begun into a fire that struck the Hajer Hotel building in Makkah on Sunday with civil defence investigators taking samples from the scene for analysis, and taking statements from witnesses.

By Mariam Al Hakeem, Correspondent  
Published: 23:45 October 21, 2008

**GULF NEWS**



A fire broke out in Makkah early Sunday in the Hajer Hotel, a high-rise under construction. The building is only a few metres away from the Grand Mosque.

Image Credit: EPA





hour of wind and dust General Safety Instructions

User Name:  Password:

Search:

Civil Defense » English » Accidents

A fire in the forestry of Bin Qasim

Home

- News
- Accidents
- Civil Protection
- Safety
- Fire Fighting
- Training
- Aviation
- Machineries & Tech.
- Public Relations
- Preventive Awareness
- Kids Corner

CE-MAIL

Government

New teams of firefighters, three rescue teams, and thirteen fire intervention units in Riyadh, were capable of controlling over the fire that

04/03/2010 / SAUDI ARABIA

### Jeddah's architectural heritage goes up in smoke

fire | Saudi Arabia



The historic centre of Jeddah found itself engulfed in flames on Wednesday. The inferno -- which saw seven ancient buildings burnt down and three others destroyed -- is being blamed on a lack of maintenance in the area, poor housing conditions of immigrants, and arson.

The fire started in the middle of the afternoon in the old part of the city, known for its ancient buildings and wooden balconies, or rawashins. Nobody was seriously injured.



# Safety Design in Buildings

# Qatar



DOHA: A fire at a nursery in a main shopping centre in the Qatari capital killed 19 people including 13 children

Fire in Villagio Mall , Qatar – in May 2012 ( 19 killed – 13 were nursery kids)

Horror as toddlers are left trapped in first floor nursery after staircase collapses

Firefighters forced to break through roof to evacuate victims

Relative of one two-year-old victim said building did not appear to have fire alarms or sprinklers





# Safety Design in Buildings

## Building or structure fires [\[edit source\]](#)

---

*This is an incomplete list, which may never be able to satisfy particular standards for completeness. You can help by expanding it with reliably sourced entries.*

### BC [\[edit source\]](#)

- 586 BC—[Temple in Jerusalem \(the first\)](#) burned by [Nebuchadnezzar](#) king of the [Babylonians](#)
- 480 BC—[Acropolis of Athens](#) burnt during [Second Hellenio-Persian War](#)
- 356 BC—[Temple of Artemis at Ephesus](#), arson by [Herostratus](#)
- 330 BC—[Persepolis](#) destroyed by fire after its capture by [Alexander the Great](#)
- c. 50 BC—[Library of Alexandria](#) burned during siege (possibly accidental)

### AD through 1700s [\[edit source\]](#)

- 70—[Temple in Jerusalem \(the second\)](#) burned by [Roman Empire](#) troops under general [Titus](#)
- 272—[Library of Alexandria](#) possibly burned during occupation of [Alexandria](#)
- 391—[Library of Alexandria](#) possibly burned by order of Roman Emperor [Theodosius I](#)  
*Note: evidence is scant for all four fires, but the library was eventually destroyed*
- 1190—Fire at [Clifford's Tower](#), [York](#), [England](#) kills at least 150 [Jews](#)
- 1561—[Fire of Valladolid](#) (21 September) destroys a tenth of the city, including 440 houses.
- 1568—The Great Fire of [Ferrol](#) which reduced to rubble the old medieval town
- 1577—Fire in the [Doge's Palace](#), [Venice](#), destroyed major works by [Bellini](#), [Titian](#) and [Tintoretto](#)
- 1608—First settlement in [Jamestown](#) burns
- 1613—[Globe Theatre](#), [London](#) burned due to mishap
- 1652—Town hall of [Amsterdam](#) burnt down. Treasures and important historical charters were destroyed.
- 1671—Much of the monastery of the [Escorial](#) outside [Madrid](#) burned in a fire lasting 15 days, destroying large numbers of artworks, books and manuscripts.
- 1697—The medieval "[Tre Kronor](#)" [Royal Castle in Stockholm](#) burned down and was eventually replaced by the present palace.
- 1698—The Tudor and Stuart Palace of [Whitehall](#), [London](#) burned, except for [Inigo Jones's Banqueting House](#). The ruins were demolished.
- 1727—Fire during puppet show in barn at [Burwell](#), [Cambridgeshire](#), [England](#), killed 78 (including 51 children)

# Safety Design in Buildings

June 1883, Victoria Hall, Sunderland, Great Britain

183 children, aged between 3 and 14, were crushed to death in a stampede for the stage when free toys were offered. The disaster is the worst of its kind in British history.

## Events

At the end of the show an announcement was made that children with certain numbered tickets would be presented with a prize upon exit. At the same time entertainers began distributing gifts from the stage to the children in the stalls. **Worried about missing out on the treats, many of the estimated 1,100 children in the gallery stampeded toward the staircase leading downstairs. At the bottom of the staircase, the door had been opened inward and bolted in such a way as to leave a gap only wide enough for one child to pass at a time.** It is believed this was to ensure orderly checking of tickets. With few accompanying adults to maintain order, the children surged down the stairs toward the door. Those at the front became trapped, and were crushed to death by the weight of the crowd behind them.

When the adults in the auditorium realised what was happening they rushed to the door, but could not open it fully as the bolt was on the children's side. Caretaker Frederick Graham ran up another staircase and diverted approximately 600 children to safety.<sup>[1]</sup> Meanwhile, the other adults pulled the children one by one through the narrow gap, before one man pulled the door from its hinges.

In his 1894 account of the incident, survivor William Codling, Jr., described the crush, and the realisation that people were dying:

## Aftermath

With the compressive asphyxia of 183 children between 3 and 14 years old, the disaster is the worst of its kind in British history. Queen Victoria sent a message of condolence to the grieving families. Donations were sent from all over Britain, totalling £5,000, which was used for the children's funerals and a memorial in Mowbray Park. The memorial, of a grieving mother holding a dead child, was later moved to Bishopwearmouth Cemetery, gradually fell into disrepair, and was vandalised. In 2002 the marble statue was restored, at a cost of £63,000, and moved back to Mowbray Park with a protective canopy.

Newspaper reports at the time triggered a mood of national outrage and **the resulting inquiry recommended that public venues be fitted with a minimum number of outward opening emergency exits, which led to the invention of 'push bar' emergency doors.** This law still remains in full force as of 2013. No one was prosecuted for the disaster; the person responsible for bolting the door was never identified. The Victoria Hall remained in use until 1941 when it was destroyed by a German parachute bomb.

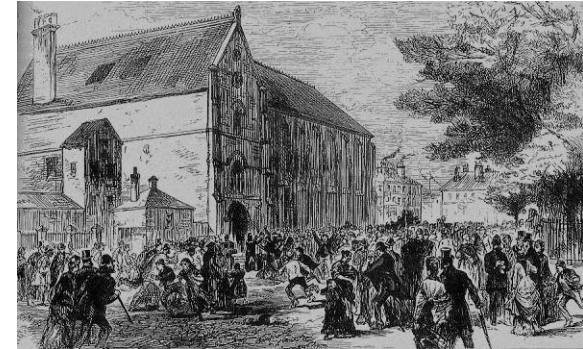



# Safety Design in Buildings

## The Iroquois Theater in 1903

The Iroquois Theater, was believed to be "**absolutely fireproof**".

Vaudeville show, starring the popular comedian **Eddie Foy**

**Architect Benjamin H. Marshall** wanted to assure the public that the Iroquois was safe.

**He studied a number of fires that had occurred in the past** and made every effort to make sure that no tragedy would occur in the new theater.

The Iroquois had **25 exits** that, it was claimed, could empty the building in less than five minutes.

The stage had also been fitted with an asbestos curtain that could be **quickly lowered to protect the audience**.

Officially, the Iroquois seated **1,600** people.

It is believed there was an overflow crowd of nearly **2,000** people filling the seats and standing four-deep in the aisles.

Another crowd filled the backstage area with **400** actors, dancers and stagehands hidden from those in the auditorium

Eddie Foy heard the commotion outside and rushed out onto the stage to see what was going on. **He implored the audience to remain seated and calm, assuring them that the theater was fireproof** and that everyone was safe.



### Collinwood school fire

The **Collinwood school fire**, **March 4, 1908**, was one of the deadliest disasters of its type in the United States. **resulted in the deaths of 172 students**, two teachers and a rescuer.

#### Fire

While the Lake View School was built with load-bearing masonry outer walls, much of the four story building's floor structure system used wooden joists. It was one wooden joist that caught fire when it was overheated by a steam pipe. The building's main staircase extended from the front doors of the building, up to the third floor, **and had no fire doors**. The stairwell acted like a chimney, helping to spread the fire quickly. Oiled wooden hall and classroom floors also fueled the fire.

**Flames quickly blocked escape routes**, leaving many students pressed against **doors that were locked or opened inward**. The flammable construction gave only minutes for evacuation. Though one fire escape was accessible at the rear of the building, not all the children found their way to the exit. **Doors to the building were equipped with common door knob latches, not the more modern crash bar type** latch. As panic leading to the crush of a large number of students in stairwell vestibules contributed to the death toll, students also died as a result of smoke inhalation and the fire itself. **Some children died jumping from second- and third-story windows**. Community members watched as victims trapped in the building were burned beyond recognition.



Lake View School, Collinwood, Ohio as it appeared before March 4, 1908.



Lake View School, Collinwood, Ohio the morning following the fire of March 4, 1908. 175 people lost their lives in the fire, making it the greatest loss of life in a fire of this type in a school in the United States to that date.



# Safety Design in Buildings

When we think of life safety during a fire the first things come to our mind are:

- Smoke alarms,
  - Sprinkler systems, and  
Fire extinguishers.
- Detection,
- Suppression
- Building Compartmentation.

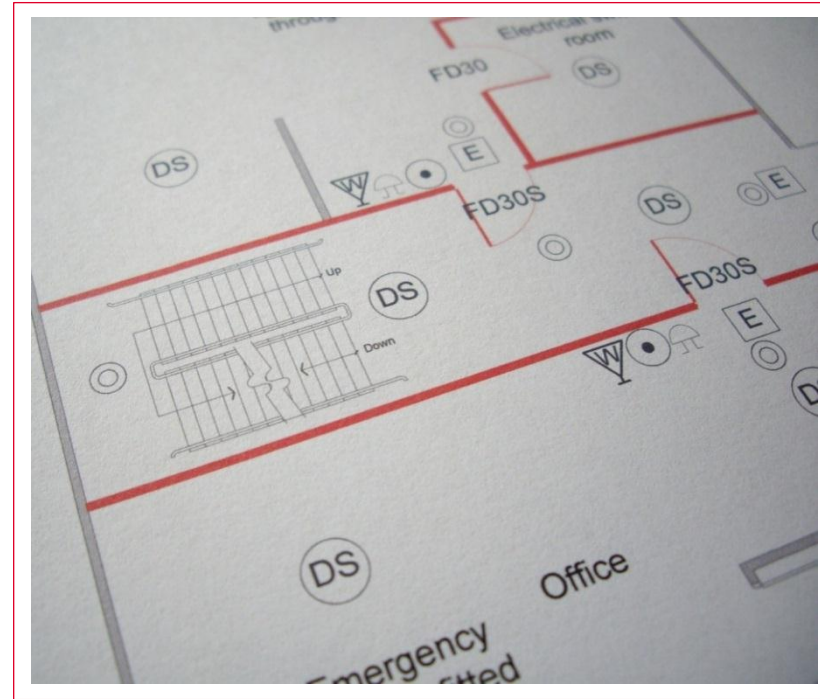
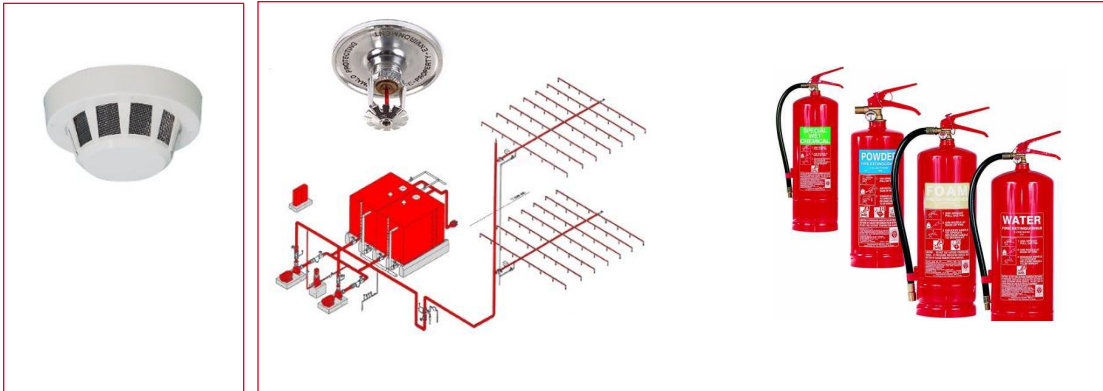

1. **Detection:** The first layer of fire protection comes from smoke and fire alarms that alert building occupants to the threat of a fire

2. **Suppression:** Strategically placed sprinklers and extinguishers can help slow or stop a fire from spreading. Such components are considered “**active**” because they **must first be triggered** before they offer protection.

3. **Building Compartmentation:** Fire- and smoke-blocking materials such as masonry, gypsum or fire-rated glass divide a building into compartments. Such “**passive**” components provide **around-the-clock protection** and can help slow the spread of fire.

# Safety Design in Buildings



**Active Components**  
**(Need trigger)**

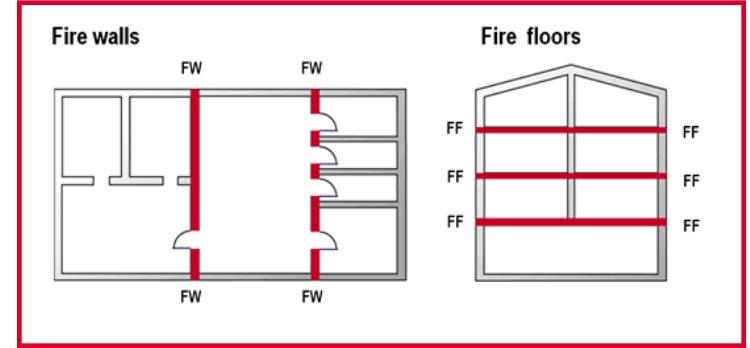

**Passive Components**  
**(Always there)**

All the three components  
are necessary,



# Safety Design in Buildings

# Codes and Standards

- Codes and standards establish the minimum criteria for meeting levels of construction, performance or quality of a product or process.

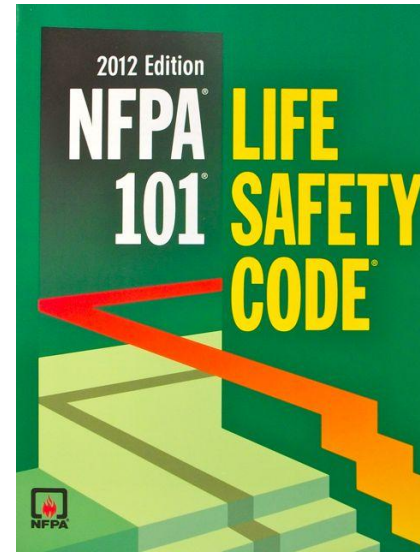

متطلبات الوقاية  
للحماية من الحريق في المباني  
طبعة الثانية ٢٠٠٣م  
الإصدار الثاني

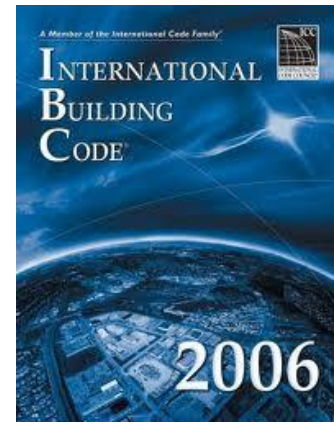
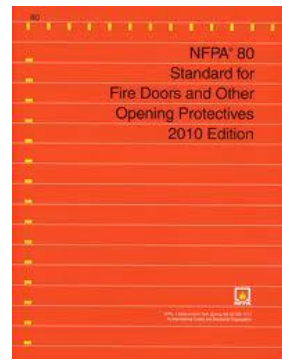

## Compliance Standards

- **NFPA 80:** Fire Doors and Other Opening Protectives
- **NFPA 101:** Life Safety Code
- **NFPA 105:** Standard for Smoke Door Assemblies and Other Opening Protectives to restrict the spread of smoke and save lives
- **NFPA 252:** Standard Methods of Fire Tests of Door Assemblies
- **ANSI/ICC A117.a:** Accessible and Usable Buildings and Facilities
- **IBC :** International Building Code

### **BS 476 - Fire test on building materials and structures.**

**Part 20: 1987** - Method for determination of the fire resistance of elements for construction (general purpose).

**Part 22: 1987** - Methods for determination of the fire resistance of non-load bearing elements for construction.

**Part 23: 1987** - Methods for determination of the contribution of components to the fire resistance of a structure.

**Part 31:** - Methods of measuring smoke penetration through door sets and shutter assemblies.

### **BS EN 1634-1: 2000 - Fire resistance tests for doors and shutter assemblies. Fire doors and shutters.**

This standard specifies the methods of tests for Fire Doors. The furnace performance and pressures are defined. Generally regarded as being **more sever than the previous BS476 fire tests.**

**BS EN 1634-3: 2004** - Fire resistance tests for door and shutter assemblies. Smoke control doors and shutters.





## Product Standards

- ▶ ■ **BHMA/ANSI A156:** Series of Product Standards for Builders Hardware.
- ▶ ■ **SDI/ANSI – A250:** Series of Standards for Steel Doors and Frames
- ▶ ■ **WDMA 1S.1A/1S.6A:** Standards for Architectural wood flush and Stile & Rail Doors.



**Basic Fire Door Requirements**



*ANSI/SDI A250.8-2003 (R2005)*  
*Revision of ANSISDI A250.8-1998*

*SDI-100*  
*Recommended Specifications for*  
*Standard Steel Doors and Frames*



SPONSOR  
**Steel Door Institute**  
Approved November 14, 2003



- **NFPA 80: Fire Doors and Other Opening Protectives**
- **NFPA 101: Life Safety Code**
- **ADA and ANSI/ICC A117.a: Accessible and Usable Buildings and Facilities**
- **IBC : International Building Code**
- **BS/EN Standards for Comparison purpose**

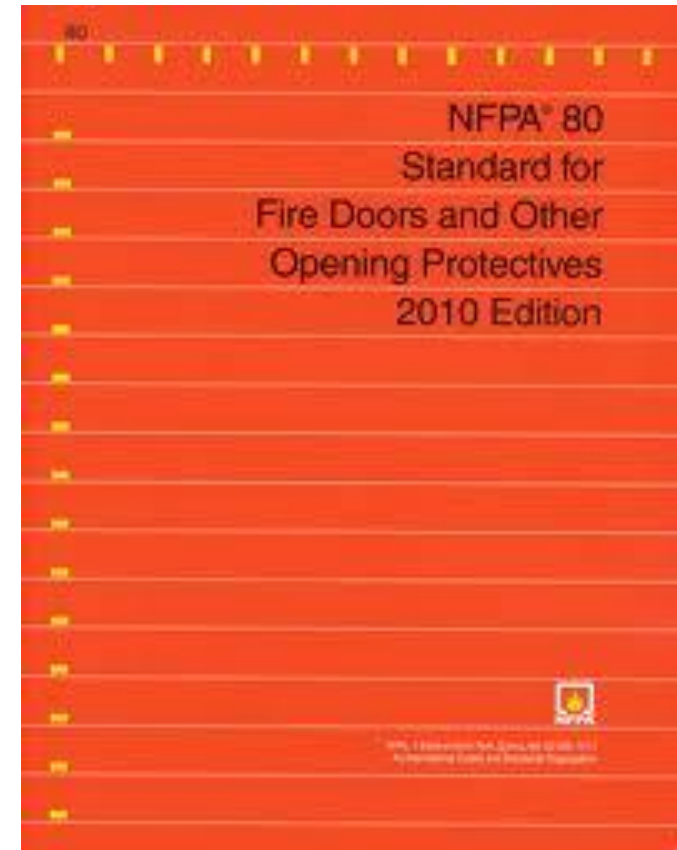

- Fire-Rated door assemblies consist of:
  - Fire-rated **frame**.
  - Fire-rated **door**.
  - Tested latching devices (**Latch lock**)
  - Tested door closing devices. (**Door Closer**)



- Glazed Vision panel in fire rated doors.
  - Only labeled galzing material shall be used.
  - Vision panel size limits for various fire ratings.





### ■ Hinges.

1. Material to be Steel (Ferrous) or Stainless steel
2. Ball Bearing or Antifriction,
3. The Number, Size and Thickness of hinge is regulated.

No fire test required,

Need to be as per ANSI/BHMA relative standard.



ANSI/BHMA A156.1 Butts and Hinges

In BS/EN standards, the requirements are different.



BS EN 1935: 2002 - Building hardware - single axis hinges

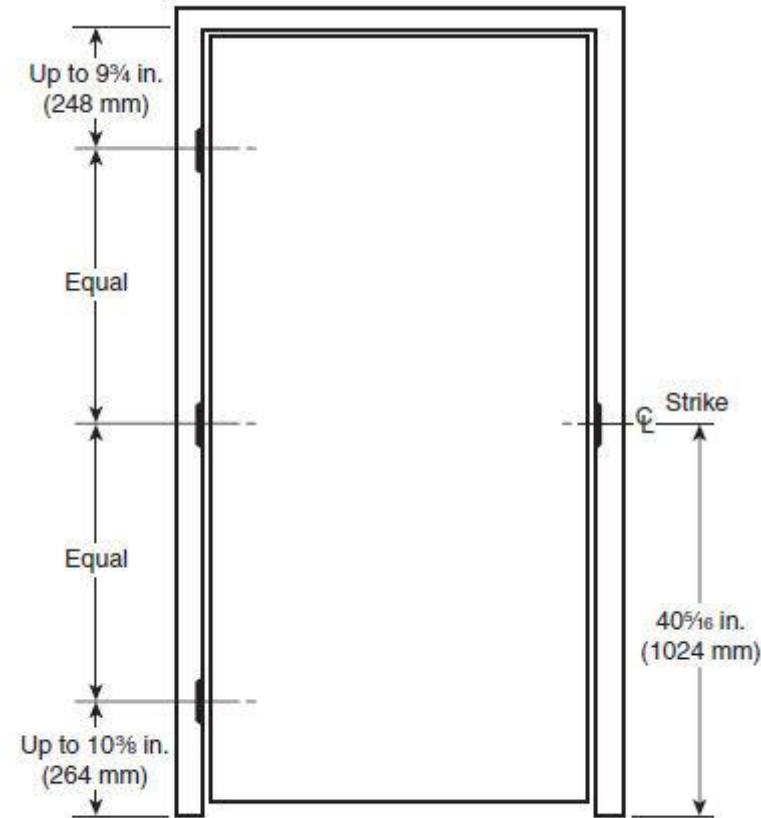

Note: On doors over 7 ft 6 in. (2.3 m), two equally spaced intermediate hinges are required.

### ■ Locks and Latches – LOCK SETS

1. Fire doors to be latched.
2. Only labeled locks and latches are allowed on fire doors.
3. The Throw of the latch to be as per fire door label.

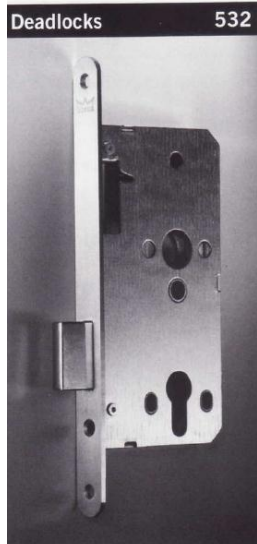

**In BS/EN standards, the requirements are different.**

#### Certification/Compliance:

**ANSI:** Meets A156.13 Series 1000, operational and security Grade 1. Meets A117.1 accessibility code and ADA requirements for barrier-free accessibility.

**UL/CUL – UL 10C Positive Pressure:** All M9000 are listed 3 hour fire rated. Locks are listed for A label and lessor class doors, 4'0" x 8'0" maximum per leaf.

**California State Reference Code:** (formerly title 19, California State Fire Marshall standard) All levers with returns, return to within 1/2" (13 mm) of door face.

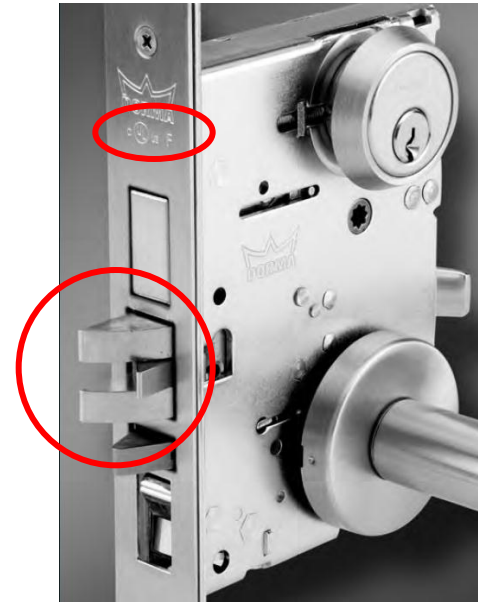

**Grade 1  
Heavy-Duty  
Mortise Locksets**

**BS EN 12209: 2003 -  
Mechanically operated locks, latches and locking plates.**

### ■ Locks and Latches – PANIC BARS.

1. Tested for both Fire Safety and Fire Protection requirements. (Labeled for both Fire and Panic).
2. Only panic hardware is not allowed on Fire doors.



**In BS/EN standards, the requirements are different.**



**BS EN 179: 2008 -**

**Emergency exit devices operated by a lever handle or push pad.**

**BS EN 1125: 2008 -**

**Emergency exit devices operated by horizontal push bar**

#### **Certification:**

- Certified/listed to ANSI/BHMA 156.3, Grade 1 for exit devices.
- U.L. and C.U.L. listed under their continuing reinspection programs and conforms to standards U.L. 10C and U.B.C. 7-2 positive pressure testing.
- Complies with NFPA 101 life safety code. Fire rated devices comply with NFPA 80 fire doors and windows.
- Devices, trim, pulls, and levers comply with the Americans for Disabilities Act, 1994, and ANSI 117.1-2003 for accessible and usable buildings and facilities.
- Contributes to U.S. Green Building Council, LEED MR Credits 2.1, 4.1, 4.2 and 5.1.
- Listed with the California Department of Forestry and Fire Protection, Office of the State Fire Marshal (medium stile devices only).
- Hurricane code approved to Miami-Dade County Florida acceptance No. 06-912.05 (medium stile devices only).
- Florida State Building Code listed (medium stile devices only).



### ■ Locks and Latches – PANIC BARS.

1. Tested for both Fire Safety and Fire Protection requirements. (Labeled for both Fire and Panic).
2. Only panic hardware is not allowed on Fire doors.

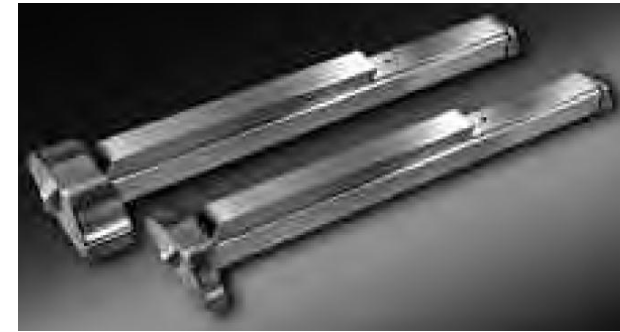

BS EN 1125: 2008 -

#### Emergency exit devices operated by horizontal push bar

Panic device push and touch bars should be installed to provide the maximum effective length but never less than 60% of the door leaf width.

NFPA 101® (2003, 2006), NFPA 5000® (2003, 2006)

7.2.1.7.1 Where a door assembly is required to be equipped with panic or fire exit hardware, such hardware shall meet the following criteria:

- (1) It shall consist of a cross bar or a push pad, the actuating portion of which extends across not less than one-half of the width of the door leaf.
- (2) It shall be mounted as follows:
  - (a) New installations shall be not less than 34 in. (865 mm), and not more than 48 in. (1220 mm), above the floor.
  - (b) Existing installations shall be not less than 30 in. (760 mm), and not more than 48 in. (1220 mm), above the floor.
- (3) It shall be constructed so that a horizontal force not to exceed 15 lbf (66 N) actuates the cross bar or push pad and latches.

### ■ Locks and Latches – PANIC BARS.



#### Where panic hardware is required by code:

*The International Building Code (2004 Supplement, 2006):*

Each door in a means of egress equipped with latches or locks serving:

- Assembly or Educational Occupancies with an occupant load of 50 people or more.
- High Hazard occupancies (any occupant load).

**NFPA 101\*** (2003, 2006), **NFPA 5000\*** (2003, 2006)

Required means of egress doors equipped with latches or locks serving:

- Assembly, Educational, or Day Care Occupancies with an occupant load of 100 people or more.
- High hazard contents areas with an occupant load in excess of 5.

**NFPA 70 - The National Electric Code (2002, 2005)** requires that certain electric rooms have doors that open in the direction of egress and are "equipped with panic bars, pressure plates, or other devices that are normally latched but open under simple pressure."

Technically, a hospital latch or paddle-type release would meet this requirement, but the fact that the words "panic bar" are used in the Code has prompted many code officials to require panic hardware. According to Article 110 of NFPA 70, personnel doors serving the following types of rooms must comply:

- Rooms housing large equipment - 600 Volts, nominal or less, 1200 amperes or more.
- Rooms housing conductors and equipment used on circuits of over 600 Volts, nominal.
- Transformer Vaults

The IBC also refers to panic hardware for electric rooms:

"Electrical rooms with equipment rated 1,200 amperes or more and over 6 feet (1829 mm) wide that contain overcurrent devices, switching devices or control devices with exit access doors shall be equipped with panic hardware and doors shall swing in the direction of egress."

### Self Closing – DOOR CLOSERS

1. Fire doors to self closing and latched at the time of fire.
2. Automatic and Power operated allowed.
3. Spring hinges, if used, to be labeled.

In BS/EN standards, the requirements are different.



BS EN 1154: 1997 - Controlled door closing devices - requirements and test methods.



ANSI/BHMA A156.4 Door Control-Closers

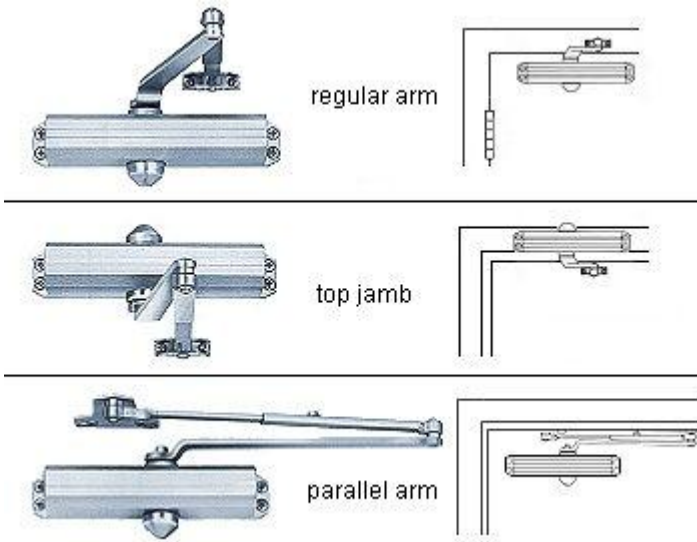



# Safety Design in Buildings

## Self Closing – DOOR CLOSERS

### Closing Speed: (see figure 5)

- ICC/ANSI A117.1 Accessible and Usable Buildings and Facilities, 2003 Edition: "404.2.7.1 Door Closers. Door closers shall be adjusted so that from an open position of 90 degrees, the time required to move the door to a position of 12 degrees from the latch is 5 seconds minimum."
- ADA Guidelines, 1994 Edition: "4.13.10\* Door Closers. If a door has a closer, then the sweep period of the closer shall be adjusted so that from an open position of 70 degrees, the door will take at least 3 seconds to move to a point 3 in (75 mm) from the latch, measured to the leading edge of the door." \* (Appendix)  
"A4.13.10 Door Closers. Closers with delayed action features give a person more time to maneuver through doorways. They are particularly useful on frequently used interior doors such as entrances to toilet rooms." (see figure 6)
- Proposed ADA Guidelines, Approved 2004: "404.2.8.1 Door Closers. Door closers shall be adjusted so that from an open position of 90 degrees, the time required to move the door to a position of 12 degrees from the latch is 5 seconds minimum."



### Opening Force:

- ICC/ANSI A117.1 Accessible and Usable Buildings and Facilities, 2003 Edition: "404.2.8 Door Opening Force. Fire doors shall have a minimum opening force allowable by the appropriate administrative authority. The required force for pushing or pulling open a door other than fire doors shall be as follows:  
1. Interior hinged doors: 5 lb (22.2 N) maximum, 2. Sliding or folding doors 5 lb (22.2 N) maximum. These forces do not apply to the force required to retract latch bolts or disengage other devices that hold the door in a closed position."  
(exterior doors not mentioned)
- ADA Guidelines, Approved 2004: "404.2.9 Door Opening Force. Fire doors shall have a minimum opening force allowable by the appropriate administrative authority. The required force for pushing or pulling open a door other than fire doors shall be as follows:  
1. Interior hinged doors: 5 lb (22.2 N) maximum, 2. Sliding or folding doors 5 lb (22.2 N) maximum. These forces do not apply to the force required to retract latch bolts or disengage other devices that hold the door in a closed position."

### ■ Protection Plates.

1. Kick plates, Mop plates to be labeled if more than 16" in height from door bottom.

### ■ Fire rated Louver doors

1. Only labeled fire door louvers shall be used in fire doors.  
(not allowed in fire escape corridors).



### Inspections (5.2\*)

5.2.1\* Fire door assemblies shall be inspected and tested not less than annually, and a written record of the inspection shall be signed and kept for inspection by the AHJ.

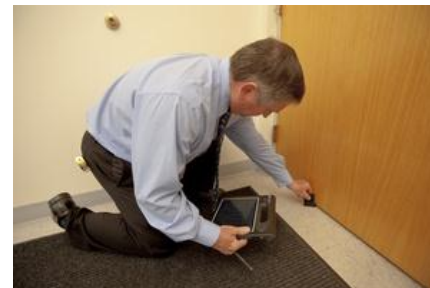



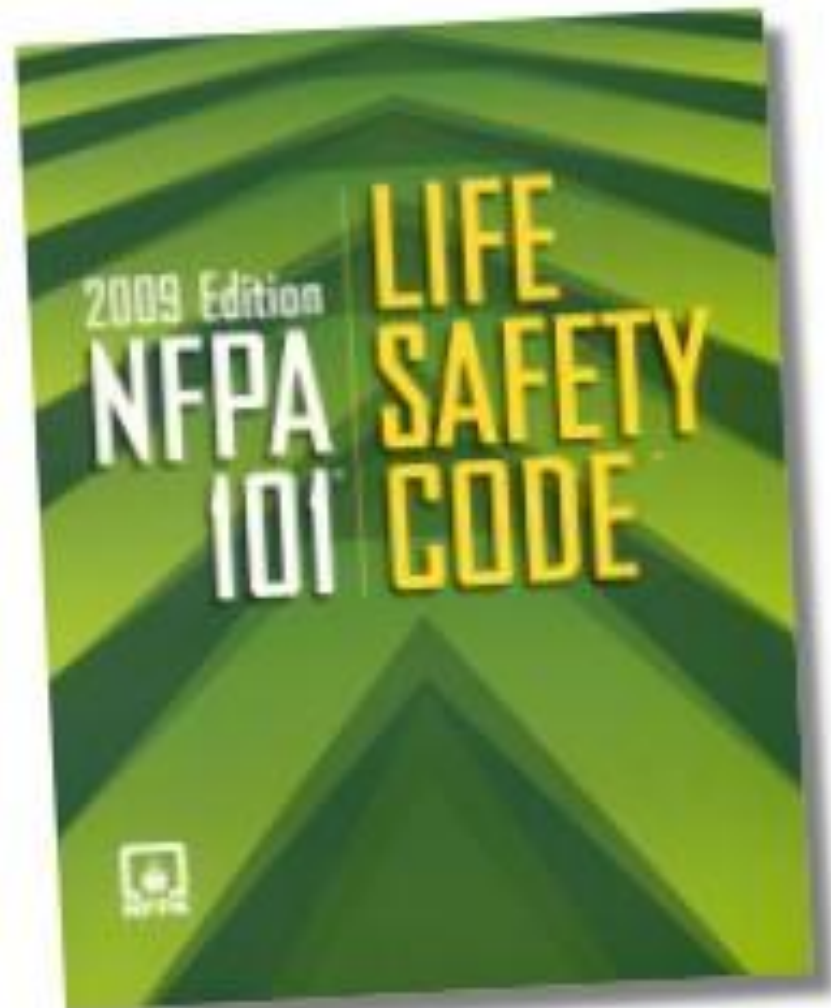

- In the **event of fire** or other emergency, occupants must be able **to vacate a building or space** quickly.
- Architects incorporate certain elements into their buildings that provide a **protected path of travel** from any point inside the building to a **safe place outside or inside** the building.



### ■ Goal of the Code

A goal of this *Code* is to provide an environment for the occupants that is reasonably safe from fire by the following means:

- (1)\* Protection of occupants not intimate with the initial fire development
- (2) Improvement of the survivability of occupants intimate with the initial fire development

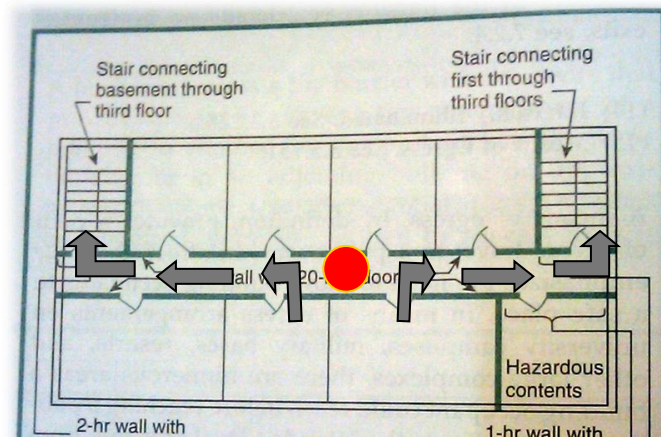

### 4.5 Fundamental Requirements

- ▶ 1. Provide for adequate safety without dependence on any single safeguard.
2. Provide an appropriate degree of life safety considering the size, shape, and nature of the occupancy.
3. Provide for backup or redundant egress arrangements.
4. Ensure that the egress paths are clear, unobstructed, and unlocked.
5. Ensure that the exits and egress routes are clearly marked to avoid confusion and provide the cues needed for their effective use.
6. Provide adequate lighting.
7. Ensure prompt occupant response by providing early warning of fire.
8. Ensure that required systems facilitate and enhance situation awareness.
9. Ensure the suitable enclosure of vertical openings.
10. Ensure compliance with applicable installation standards.
11. Maintain all required features in proper working order.



### ■ Goal of the Code

A goal of this *Code* is to provide an environment for the occupants that is reasonably safe from fire by the following means:

- (1)\* Protection of occupants not intimate with the initial fire development
- (2) Improvement of the survivability of occupants intimate with the initial fire development

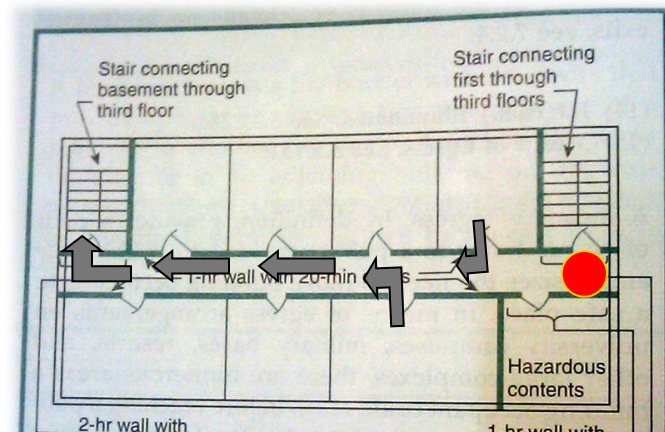

### 4.5 Fundamental Requirements

1. Provide for adequate safety without dependence on any single safeguard.
2. Provide an appropriate degree of life safety considering the size, shape, and nature of the occupancy.
3. Provide for backup or redundant egress arrangements.
4. Ensure that the egress paths are clear, unobstructed, and unlocked.
5. Ensure that the exits and egress routes are clearly marked to avoid confusion and provide the cues needed for their effective use.
6. Provide adequate lighting.
7. Ensure prompt occupant response by providing early warning of fire.
8. Ensure that required systems facilitate and enhance situation awareness.
9. Ensure the suitable enclosure of vertical openings.
10. Ensure compliance with applicable installation standards.
11. Maintain all required features in proper working order.

### ■ Goal of the Code

A goal of this *Code* is to provide an environment for the occupants that is reasonably safe from fire by the following means:

- (1)\* Protection of occupants not intimate with the initial fire development
- (2) Improvement of the survivability of occupants intimate with the initial fire development



### 4.5 Fundamental Requirements

1. Provide for adequate safety without dependence on any single safeguard.
2. Provide an appropriate degree of life safety considering the size, shape, and nature of the occupancy.
3. Provide for backup or redundant egress arrangements.
4. Ensure that the egress paths are clear, unobstructed, and unlocked.
5. Ensure that the exits and egress routes are clearly marked to avoid confusion and provide the cues needed for their effective use.
6. Provide adequate lighting.
7. Ensure prompt occupant response by providing early warning of fire.
8. Ensure that required systems facilitate and enhance situation awareness.
9. Ensure the suitable enclosure of vertical openings.
10. Ensure compliance with applicable installation standards.
11. Maintain all required features in proper working order.

### ■ Goal of the Code

A goal of this *Code* is to provide an environment for the occupants that is reasonably safe from fire by the following means:

- (1)\* Protection of occupants not intimate with the initial fire development
- (2) Improvement of the survivability of occupants intimate with the initial fire development



### 4.5 Fundamental Requirements

1. Provide for adequate safety without dependence on any single safeguard.
2. Provide an appropriate degree of life safety considering the size, shape, and nature of the occupancy.
3. Provide for backup or redundant egress arrangements.
4. Ensure that the egress paths are clear, unobstructed, and unlocked.
5. Ensure that the exits and egress routes are clearly marked to avoid confusion and provide the cues needed for their effective use.
6. Provide adequate lighting.
7. Ensure prompt occupant response by providing early warning of fire.
8. Ensure that required systems facilitate and enhance situation awareness.
9. Ensure the suitable enclosure of vertical openings.
10. Ensure compliance with applicable installation standards.
11. Maintain all required features in proper working order.



### ■ Classification of Occupancies

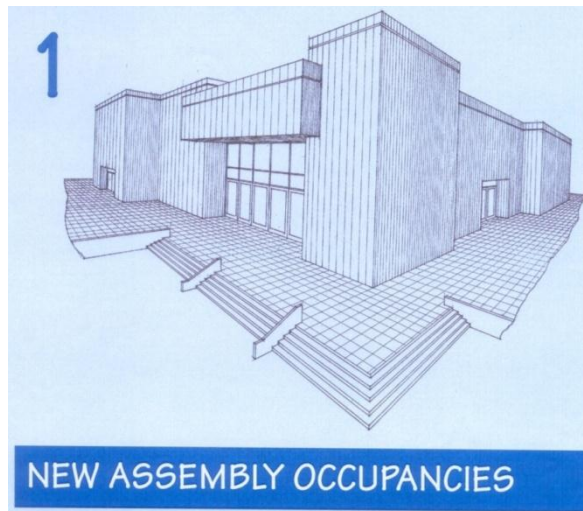

#### 6.1.2 Assembly.

For requirements, see Chapters 12 and 13.

**6.1.2.1\* Definition — Assembly Occupancy.** An occupancy (1) used for a gathering of 50 or more persons for deliberation, worship, entertainment, eating, drinking, amusement, awaiting transportation, or similar uses; or (2) used as a special amusement building, regardless of occupant load.



#### 6.1.3 Educational.

For requirements, see Chapters 14 and 15.

**6.1.3.1\* Definition — Educational Occupancy.** An occupancy used for educational purposes through the twelfth grade by six or more persons for 4 or more hours per day or more than 12 hours per week.

**A.6.1.3.1 Educational Occupancy.** Educational occupancies include the following:

- (1) Academies
- (2) Kindergartens
- (3) Schools

### ■ Classification of Occupancies

#### Hospital



#### 6.1.5 Health Care.

For requirements, see Chapters 18 and 19.

**6.1.5.1\* Definition — Health Care Occupancy.** An occupancy used to provide medical or other treatment or care simultaneously to four or more patients on an inpatient basis, where such patients are mostly incapable of self-preservation due to age, physical or mental disability, or because of security measures not under the occupants' control.

**A.6.1.5.1 Health Care Occupancy.** Health care occupancies include the following:

- (1) Hospitals
- (2) Limited care facilities
- (3) Nursing homes

#### Prison



#### 6.1.7 Detention and Correctional.

For requirements, see Chapters 22 and 23.

**6.1.7.1\* Definition — Detention and Correctional Occupancy.** An occupancy used to house one or more persons under varied degrees of restraint or security where such occupants are mostly incapable of self-preservation because of security measures not under the occupants' control.

### ■ Classification of Occupancies

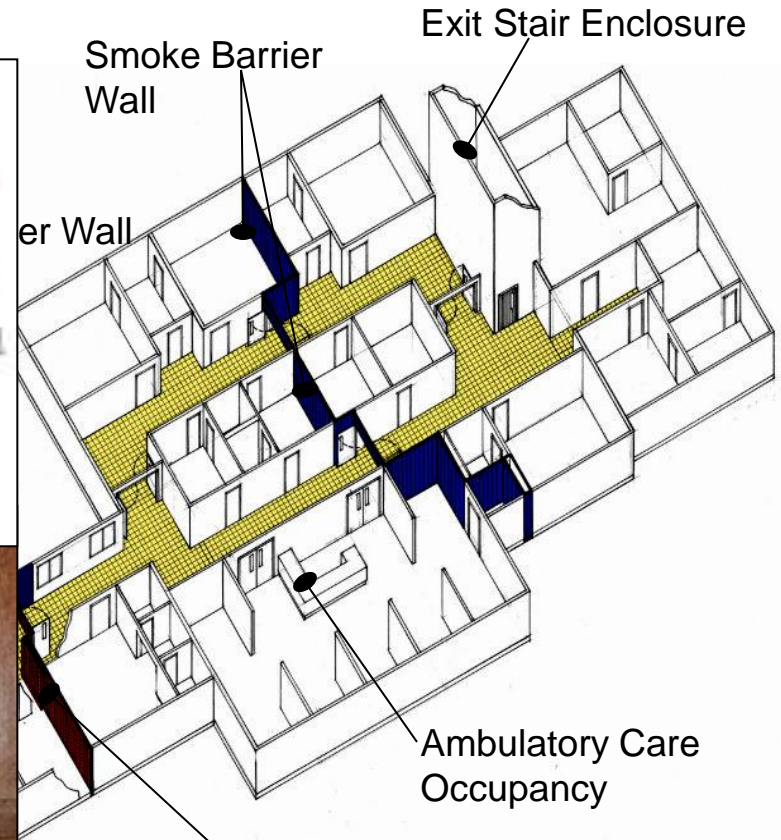
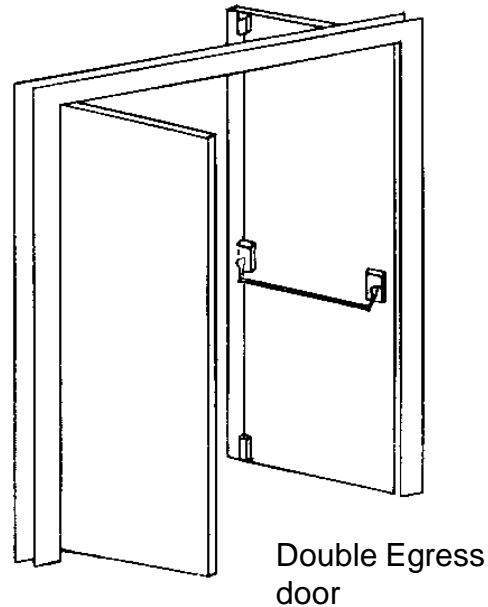
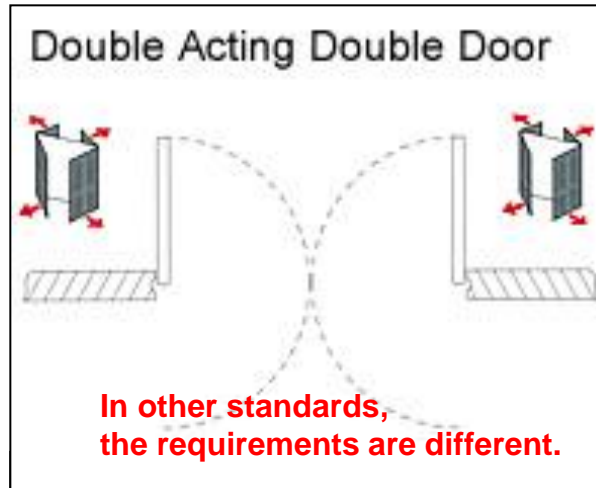
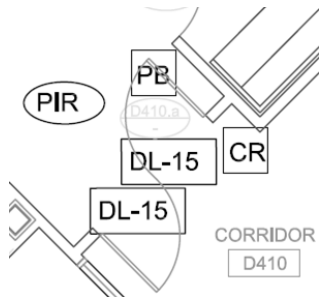

2 Hour Fire Separation Wall Between Occupancies (Horizontal Exit)

extends 10  
r Fire Rated



### When a fire breaks out,

Rapid, well-protected escape on foot to the outdoors is the best life-saving strategy for able-bodied people.

■ **Two Exits:** In any building, a person emerging from a room must have two exits.



These exits must be protected by a battery system that will energize them automatically if the building's regular lighting system fails.

■ **Compartmentation:** The corridors & stairs of each escape route must be protected from fire & smoke by fire-resistant partitions & self-closing doors.

■ **Free to exit at any time:** The doors along an escape route may not lock against persons exiting from the building, & they all must open in the direction of travel from indoors to outdoors, to prevent possible interference with the flow of escapees.



### Delayed Exit Device



# Safety Design in Buildings

## NFPA 101: Life Safety Code

■ **Exit doors** in buildings that hold large numbers of people, particularly schools, theaters, & athletic assembly buildings, must be provided with **panic hardware** that opens the door automatically upon pressure from within.

■ **Break out Sliding and Revolving doors:** Sliding and Revolving doors must be made so that they fold outward & provide unrestricted exitway.

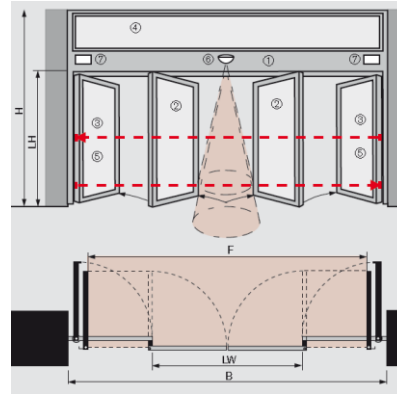
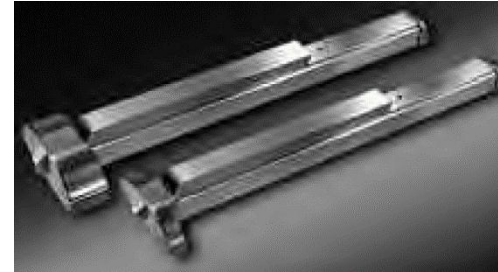

**DORMA** KTV-3  
KTV-4

Escape route

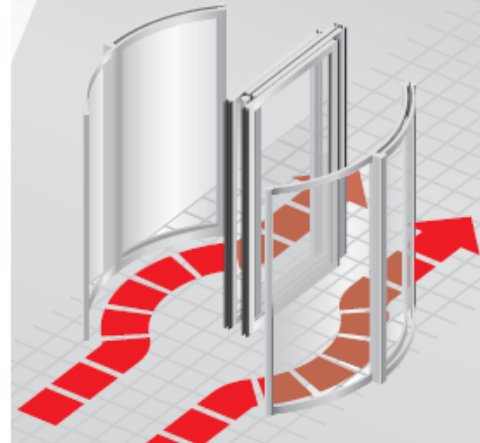

The bookfold mechanism for the door wings offers a special folding function. The folding mechanism enables the wings to be folded together almost in parallel, thereby giving the largest possible passage width. This folding capability of the wings makes these doors suitable for installation in emergency exits and escape routes.

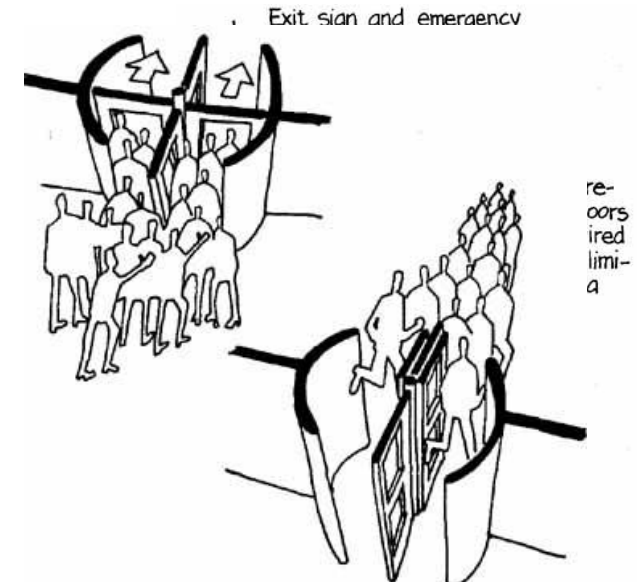

# Safety Design in Buildings

## The Iroquois Theater in 1903

The Iroquois Theater, was believed to be "**absolutely fireproof**".

Vaudeville show, starring the popular comedian **Eddie Foy**

**Architect Benjamin H. Marshall** wanted to assure the public that the Iroquois was safe.

**He studied a number of fires that had occurred in the past** and made every effort to make sure that no tragedy would occur in the new theater.

The Iroquois had **25 exits** that, it was claimed, could empty the building in less than five minutes.

The stage had also been fitted with an asbestos curtain that could be **quickly lowered to protect the audience**.

Officially, the Iroquois seated **1,600** people.

It is believed there was an overflow crowd of nearly **2,000** people filling the seats and standing four-deep in the aisles.

Another crowd filled the backstage area with **400** actors, dancers and stagehands hidden from those in the auditorium

Eddie Foy heard the commotion outside and rushed out onto the stage to see what was going on. **He implored the audience to remain seated and calm, assuring them that the theater was fireproof** and that everyone was safe.





# Safety Design in Buildings

## The Iroquois Theater in 1903

Architectural openings and Codes & Standards - **the missing link.**

- **The gallery and upper balconies sustained the greatest loss of life** as the patrons had been **trapped by locked doors** at the top of the stairways. The firefighters found 200 bodies stacked there.
- When it was all over, 572 people died in the fire and more died later, bringing the eventual **death toll up to 602, including 212 children**

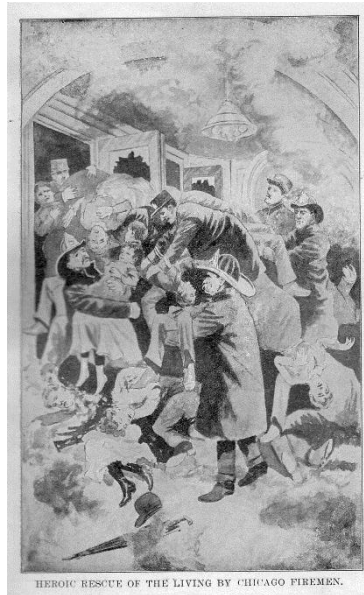
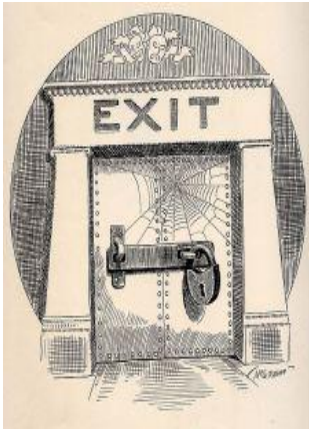

Investigators examine one of the **locked stairwell gates** that prevented patrons from fleeing the theater during the fire

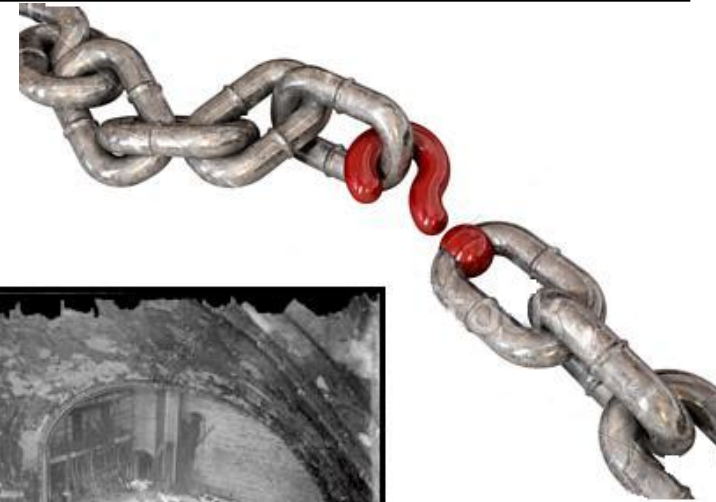

### Architectural openings and Codes & Standards - **the missing link.**

#### The investigation discovered that:

- Two **vents of the building's roof**, which had not been completed in time for the theater's opening, were supposed to filter out smoke and poisonous gases in case of a fire. However, the unfinished **vents had been nailed shut** to keep out rain and snow. That meant that the smoke had nowhere to go but back into the theater, literally suffocating those audience members who were not already burned to death.
- Another finding showed that the supposedly "fireproof" **asbestos curtain was really made from combustible materials**. It would have never saved anyone at all.
- The owners had decided **that sprinklers were too unsightly and too costly and had never had them installed**.
- To make matters worse, the management also established a policy **to keep non-paying customers** from slipping into the theater during a performance --- They quietly **bolted nine pair of iron panels over the rear doors and installed padlocked**, accordion-style gates at the top of the interior second and third floor stairway landings.
- And just as tragic was the idea they came up with **to keep the audience from being distracted** during a show. They ordered **all of the exit lights to be turned off!** One exit sign that was left on led only to ladies restroom and another to a locked door for a private stairway. And as mentioned already, **the doors of the outside exits**, which were supposed to make it possible for the theater to empty in five minutes, **opened to the inside (Door Swinging in)**, not to the outside.

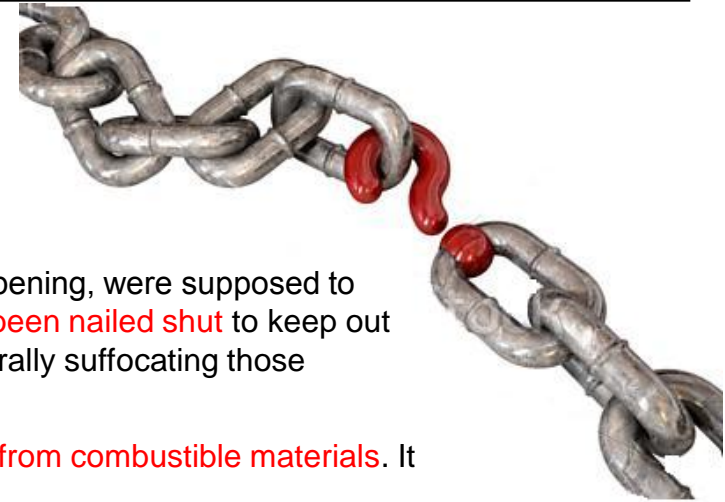



- 2008—Wuwang Club fire in Shenzhen, China on September 20, killing 43.<sup>[42][59]</sup>
- 2008—Video Parlour Cats fire by arsonist in Nanba, Osaka, Japan, killing 15 and injuring 10 on October 1
- 2009—Santika Club fire, Bangkok, Thailand, kills 66 on January 1.
- 2009—Nakumatt supermarket fire, Nairobi, Kenya, kills 29 on January 28.
- 2009—Great Beijing Mandarin Oriental Hotel fire of February, 2009 caused by fire works, 1 death.
- 2009—Bashundhara City mall fire killed 7 people on March 13, 2009 in Dhaka, Bangladesh
- 2009—Homeless hostel fire in Kamień Pomorski, Poland kills 23 on April 13.
- 2009—ABC daycare center fire kills 47 in Hermosillo, Mexico on June 5.
- 2009—Lakanal House tower block fire kills 6 in Camberwell, London, United Kingdom on July 3.
- 2009—Three alarm fire at a deli in Buffalo, New York kills Lieutenant Charles "Chip" McCarthy of Rescue 1 and Jonathan "Sim" Croom of Ladder 7 on August 24.<sup>[60]</sup>
- 2009—Taldykorgan Regional Drug Rehabilitation Hospital fire in Almaty Province, Kazakhstan, kills 38 on September 13.<sup>[citation needed]</sup>
- 2009—Perm Lane Horse Night club fire in Perm, Russia kills 153 people and injures over 140 on December 4.<sup>[61][62]</sup>
- 2009—Medan Karaoke bar fire in Medan of the Indonesian island of Sumatra kills 20 on December 4<sup>[63]</sup>
- 2010—2010 Tioman Island fire in Pulau Tioman, Malaysia. No deaths, 12 injured.
- 2010—2010 Bangkok riots in Thailand, burned BEC TV3, CentralWorld and many buildings.
- 2010—2010 San Bruno explosion in San Bruno, California, six-alarm fire from a gas main killing at least 4 and destroying dozens of homes on September 10.
- 2010—2010 Shanghai fire,<sup>[64]</sup> high-rise apartment building fire kills at least 53.
- 2010—A fire in a prison in Santiago, Chile kills at least 81 inmates; the country's deadliest ever prison incident.
- 2010—March 23, Stephen Court historic building fire in Kolkata, India kills at least 42.<sup>[65]</sup>
- 2011-September 4, Bastrop, Texas, 2 people were killed, 34,000 acres burned, over 1000 houses and other structures destroyed
- 2011—November 21, Delhi, India 15 killed and at least 36 injured at a eunuch festival caused by electrical short circuit.<sup>[66]</sup>
- 2011—December 9, AMRI hospital Kolkata, West Bengal kills at least 90. Most deaths caused by toxic fumes spreading through ducts of the Central air conditioning system.<sup>[67]</sup>
- 2012—January 2, Propane tanks at a dentist office in Laredo, Texas cause an explosion heard several miles away. No deaths; but millions of dollars in reported damage within a 3000 meter radius.<sup>[68]</sup>
- 2012—A prison fire in Comayagua, Honduras kills at more than 361 inmates on 14 February.<sup>[69]</sup>
- 2012—A massive fire sweeps through a market in Tegucigalpa, Honduras, destroying between 500 and 1800 stalls and injuring 11 people.<sup>[70]</sup>
- 2012—April 3, A fire in a Moscow market kills 17 migrant workers.<sup>[71]</sup>
- 2012, May 6 -explosions and a fire at a petrochemical plant, specifically Bangkok Synthetics Plant for synthetic rubber, in the Map Ta Phut industrial estate in Rayong Province, Thailand killed 12 people and injured more than 100.<sup>[72]</sup>
- 2012, August 25 - Explosion and fire at Paraguaná Refinery Complex kills 48 and injures 151 people.<sup>[73][74]</sup>



# Safety Design in Buildings

Architectural openings and Codes & Standards - **the missing link.**

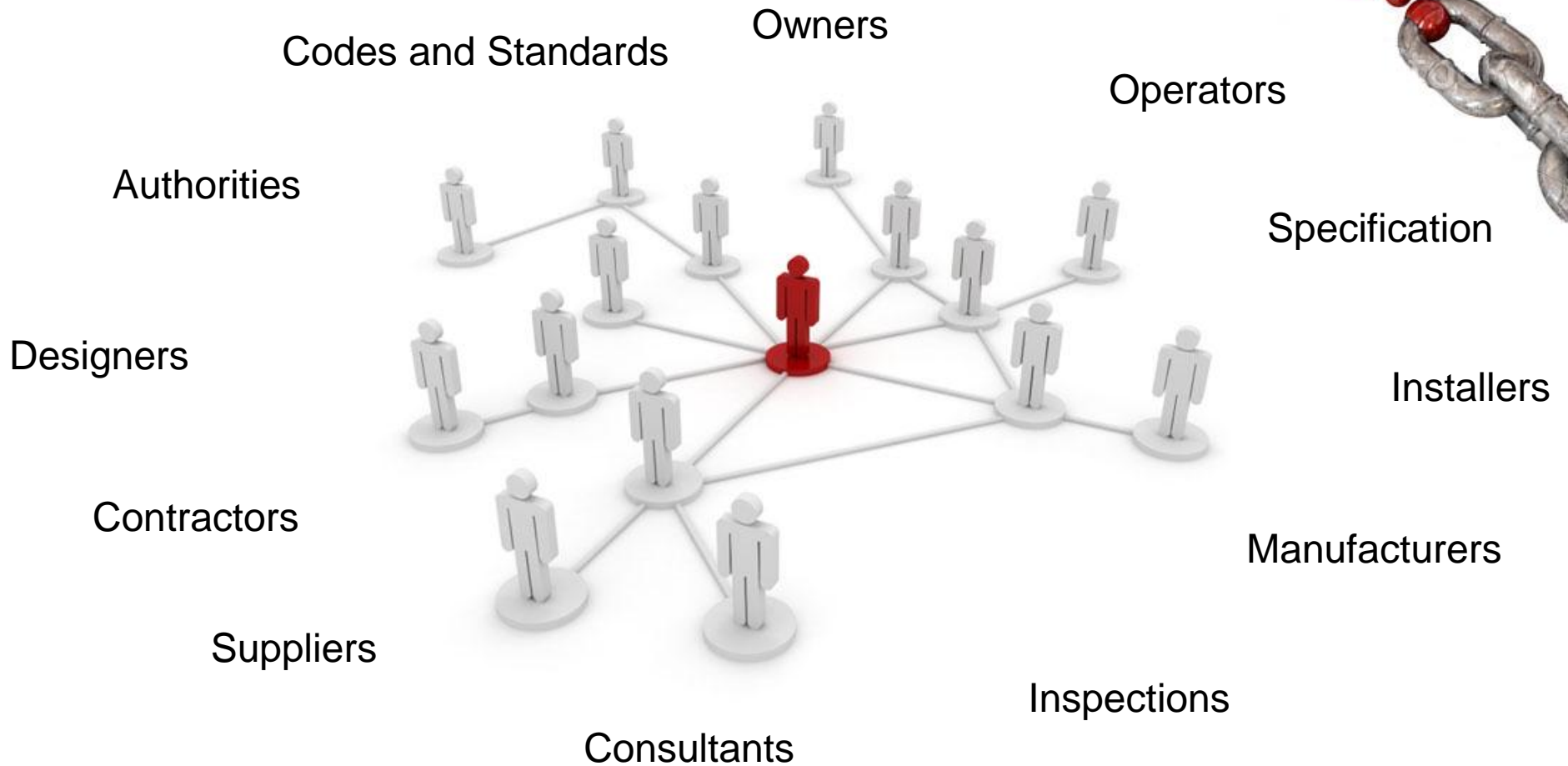



## Safety Design in Buildings



Architectural openings and  
Codes & Standards - **the missing link.**

---



**Altaf A. Afridi, PMP, LEED AP, FDAI**

Riyadh 30 Sep/1 Oct 2013

**Thank you**

This concludes The American Institute of Architects Continuing Education Systems Course  
Please do not hesitate to contact for any queries on life safety in buildings and trainings to your staff.

[altaf@dormagulf.com](mailto:altaf@dormagulf.com), [00971-50-5507892](tel:00971-50-5507892)